



1982-87 CHEVY EL CAMINO

2 Panel Sequential LED Taillight Kit w/LED Reverse Installation Kit

Kit Contents:

- **2** LED panels
- **1** power wire with t-tap
- **1** driver side panel harness, 24"
- **1** passenger side panel harness, 48"
- **2** panel extension harnesses, 12"
- **1** harness crimp kit

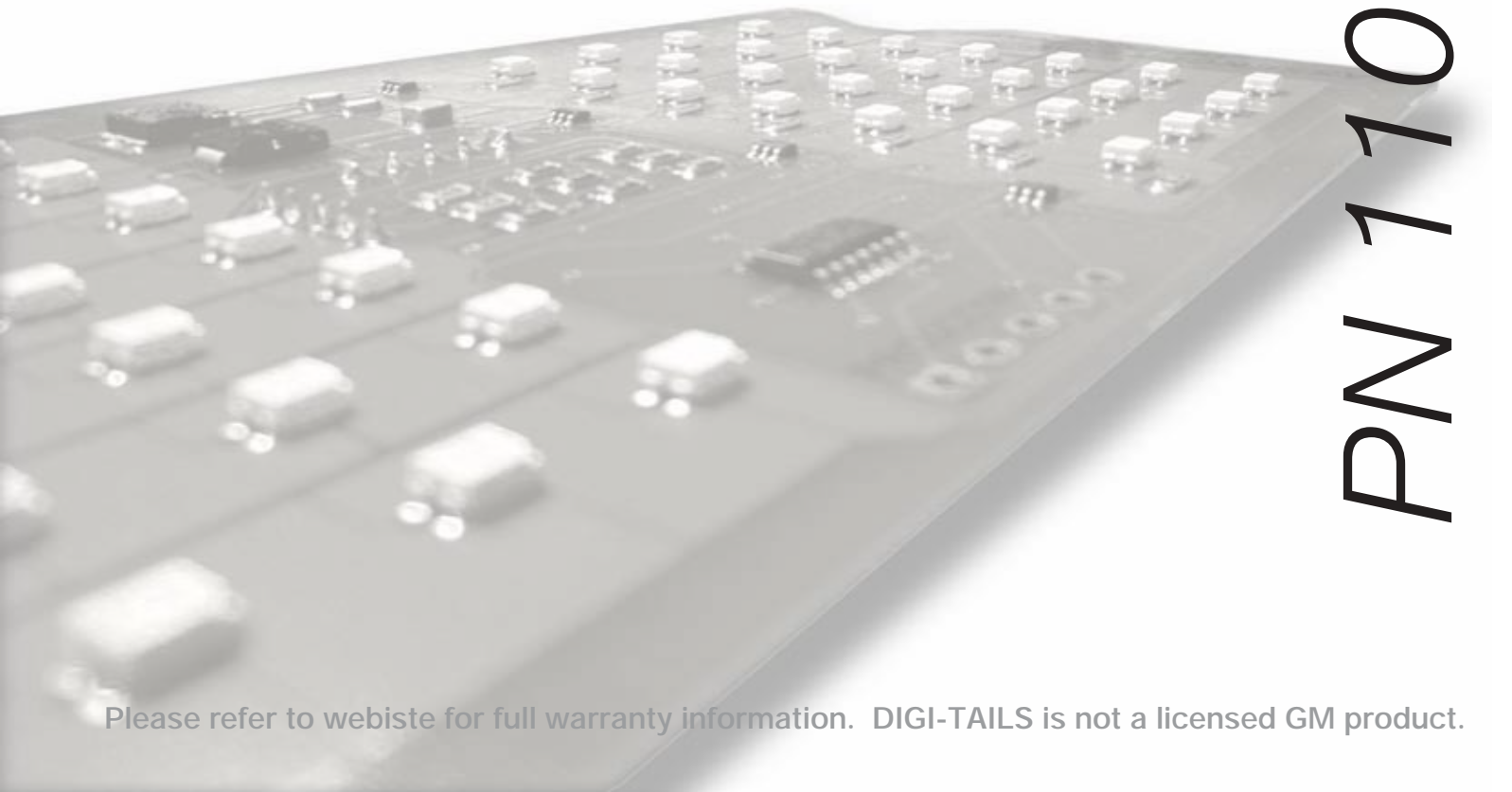

PN 1101482

Note

The LED boards are shipped with the slide switch set to sequential mode. We recommend that all slide switches be set to the same setting (either standard or sequential).

Please follow all local laws concerning exterior lighting.

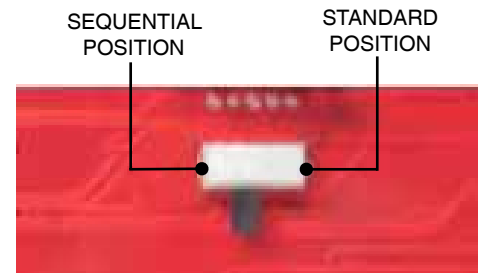

Shown in sequential mode

Hint

You may begin with the LED panel installation, however, you will need to complete the wiring modifications before the LED panels and housings are paired as one. Read over the entire instruction guide to determine the method that works best for you.

LED PANEL INSTALLATION

1. Cut off the power to your car.

Open the hood of your car. Disconnect the negative terminal from the battery, which will cut off the power in your car. To verify that the power is disconnected, press the brake pedal; your brake lights should not turn on.

2. Remove the tail lights.

Turn the light sockets counter-clockwise to remove them from the tail light housings. As a safety precaution, remove the bulbs from the sockets. Put them aside since they will no longer be needed. Remove the tail light housing assembly from the car.

3. Modify the tail lights.

Remove the tail light housing assembly from the car. You will need to cut off the tail light housing socket pockets so that you are left with is the lens and the housing perimeter. Take your time separating the two apart and don't use excessive force to break the lens free. It is best to slowly slowly trim away the housing pockets little at time around the perimeter of the lens.

1. Secure the housing into a vise or clamp to keep it into position. Take care not to scratch up or crunch the housing.



2. Using a cut off wheel or a Dremel, first make a cut around the perimeter of the socket buckets.



3. Cut into the remaining sides of the housing buckets. This will loosen them to the point where they will easily separate from the lens.



NOTE:

Be sure to cut parallel with the lens and not cut into it.

4. Pull off the cut plastic buckets. Clean the cut edge smooth and remove any remaining hanging plastic.



4. Identify the LED panels.

On the backside each LED panel is marked PASSENGER or DRIVER SIDE.



PASSENGER side shown.

5. Attach the LED panel.

1. Spread the included silicone around the perimeter of the lens edge.



2. Line up the **BLACK** line on the LED panel with the center divider of the lens.
Lay the panel down flat onto the lens sandwiching the silicone making sure its flat parallel with the lens.

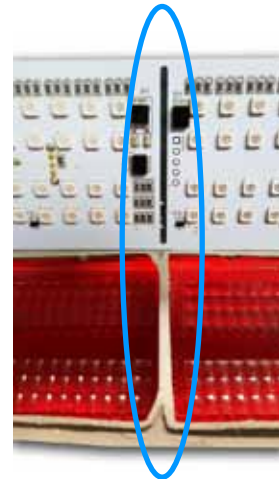

3. Using the silicone, fill in the gaps and smooth out the silicone.
Give it 24 hours to fully dry.



Fill and smooth out the silicone.











1. Review the wiring diagrams found on the last page.

Each LED panel needs four connections. However, the Brake and turn signal panels use different signals. Listed are the LED harness colors and their respective function. Note: Depending on make and harness, colors may not match.











2. Find and access the taillight wires.

Pick a point in the rear body panel between the driver's side quarter panel and the driver's side taillight housing assembly and remove the cloth tape to expose the taillight wires.

3. Splice the LED SIGNAL wires into the stock SIGNAL wires. Match the LED harness to the corresponding stock harness as shown below.**DRIVER SIDE LED panel**

LED Harness	Function	Stock harness	Notes
 Green	Brake light signal	 Dark Blue	The light socket ends on the car harness can be removed.
 Yellow	Driver side turn signal	 Yellow	The light socket ends on the car harness can be removed.
 Brown	Running/Park signal	 Brown	The light socket ends on the car harness can be removed.
 Blue	Reverse light signal	 Light Green	The light socket ends on the car harness can be removed.
 Red	Constant 12 volt		Find power at fuse panel/trunk light/dome light/fused battery feed.
 Black	Ground		Ground to Body/chassis

PASSENGER SIDE LED panel

LED Harness	Function	Stock harness	Notes
 Green	Brake light signal	 Dark Blue	The light socket ends on the car harness can be removed.
 Yellow	Passenger side turn signal	 Green	The light socket ends on the car harness can be removed.
 Brown	Running/Park signal	 Brown	The light socket ends on the car harness can be removed.
 Blue	Reverse light signal	 Light Green	The light socket ends on the car harness can be removed.
 Red	Constant 12 volt		Find power at fuse panel/trunk light/dome light/fused battery feed.
 Black	Ground		Ground to Body/chassis

4. Connect all the ground wires.

Connect all the ground wires together. Bolt them to the trunk latch support along with the original rear body harness ground. The ground connection must be good in order to operate the LED tail lights.

5. Supply the LED panel harnesses with a constant 12 volt feed using the included **Orange** power wire and T-Tap.

An Orange power wire is supplied along with a T-Tap. The orange power wire must be powered with a constant 12 volt battery supply for the LED circuitry to operate properly. You can use the included T-Tap connector to splice to a constant power source, like the dome light, trunk light, fuse box, etc.

Splice the T-Tap connector over the constant power source, then plug the orange wire into the T-Tap. The other end of the orange power wire is tied in with the red wires of all the LED panel harnesses.



1. Insert wire into T-Tap



2. Crimp with pliers



3. Plug connector into T-Tap

6. Tuck and secure the spliced wires.

Take the spliced sections and fold them over to one side and tape them in place. This will allow you to place the wiring into loom or wrap the LED panel wiring tightly away.



1. Fold wires to one side.



2. Secure with electrical tape.

Note

A wire diagram of the LED panel's harness spliced into the car's stock harness is on the last page.

Note

The LED light kits are designed for best performance when use an electronic no-load flasher. Shown here is an optional electronic no load flasher available from DIGI-TAILS, (PN 20-F2)



If you decide to use a stock bi-metal flasher, we recommend a standard-duty flasher instead of a heavy-duty flasher. If your turn signal circuit includes front and rear LED turn signals, the circuit will not have enough resistance load to operate a heavy-duty bi-metal flasher, so the no-load flasher will be required for both the turn signal and emergency flashers.

STOCK
REAR BODY
HARNESS

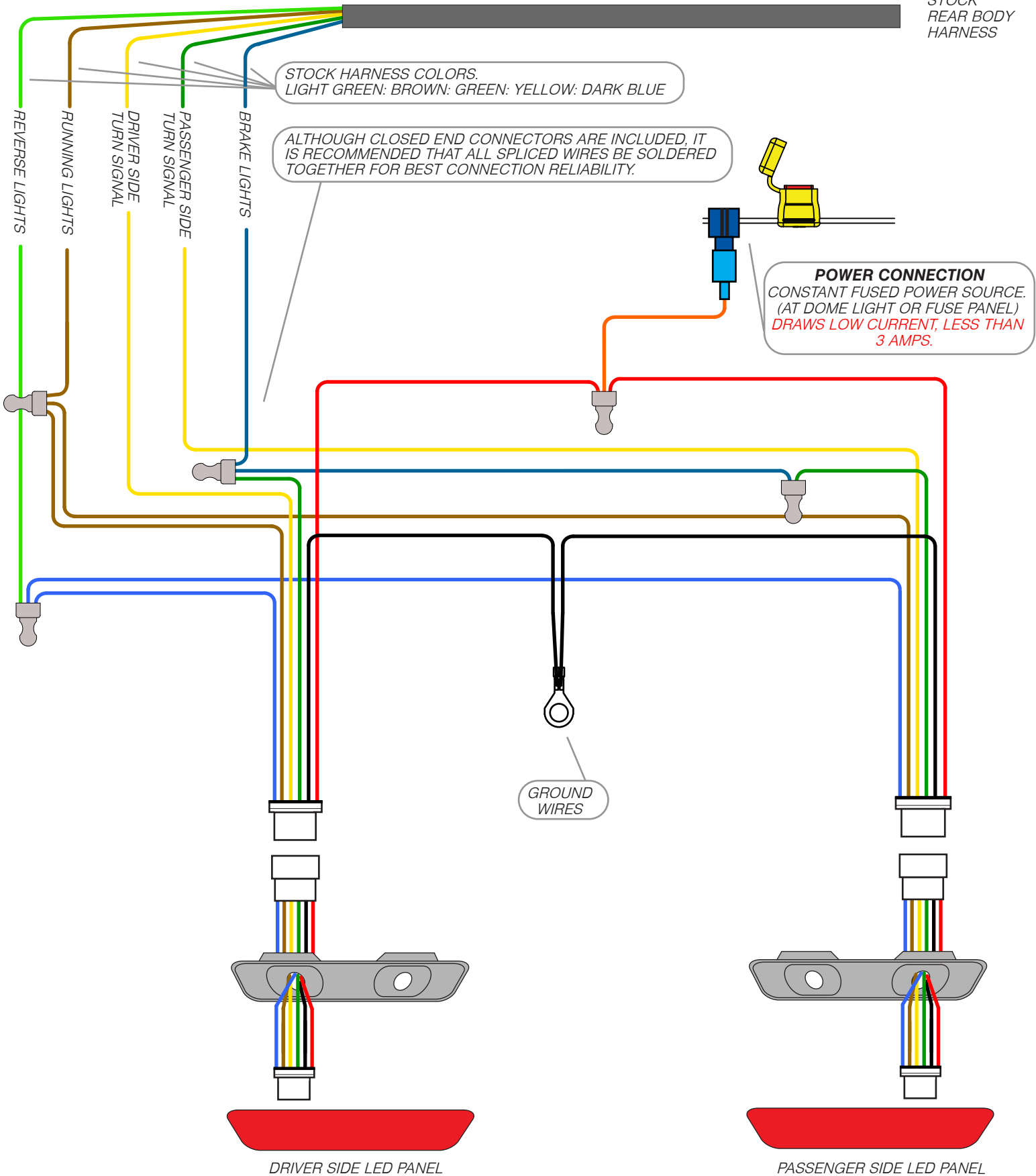

FOR KITS WITH LED REVERSE LIGHTS.
CONNECT THE LED PANELS **BLUE** WIRE TO THE VEHICLES **LIGHT GREEN** REVERSE LIGHT SOCKET WIRE.
THE OTHER WIRE ON THE REVERSE LIGHT SOCKET (GROUND WIRE) IS NOT USED.